Connection Enablement: Morwell South area

Regulatory Investment Test for Distribution (RIT-D) Options Screening Report

Friday, 19 January 2024

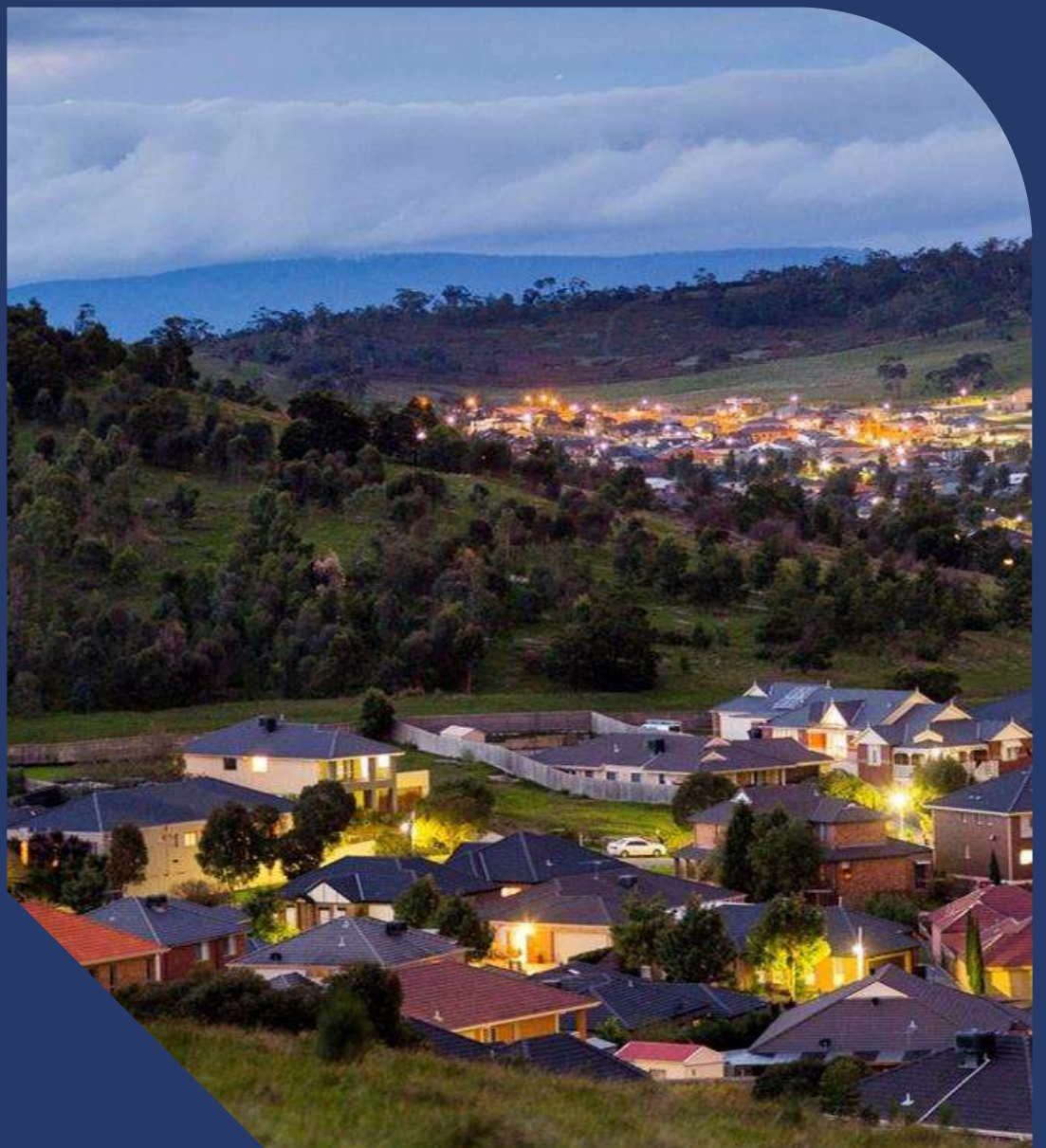

Table of contents

1. Executive summary	2
2. Introduction	3
3. Background	4
4. Identified need	5
4.1. Description	5
4.2. Assumptions	6
5. Potential credible options	8
5.1. Option 0: Do Nothing/BAU	8
5.2. Option 1: Augment No.2 line with 19/3.25 conductor	8
5.3. Option 2: Augment both lines with 19/4.75 conductor	8
5.4. Option 3: Augment both lines with 37/3.75 conductor	9
5.5. Options considered and not progressed	9
5.6. Material inter-regional network impact	9
6. Non-network options	10
6.1. Required technical characteristics of a non-network option	10
6.2. Power system security, reliability and fault levels	10
6.3. Guidance on potentially feasible options	11
6.4. Information to be included in non-network solution proposals	11
6.5. Potential payments to non-network proponents	12
7. Next steps	13
7.1. Request for submissions	13
7.2. Next stage of RIT-D process	13
Appendix – RIT-D assessment and consultation process	14

1. Executive summary

AusNet is a regulated Victorian Distribution Network Service Provider (DNSP) that supplies electrical distribution services to approximately 809,000 electricity customers. Our electricity distribution network covers eastern rural Victoria and the fringe of the northern and eastern Melbourne metropolitan area.

As expected by our customers and required by the various regulatory instruments that we operate under, AusNet aims to maintain service levels at the lowest possible cost to our customers. To achieve this, we develop plans that aim to maximise the present value of economic benefit to all those who produce, consume and transport electricity in the National Electricity Market (NEM).

Recently AusNet received connection inquiries to connect 865 MW of renewable generation to the Morwell South sub-transmission (66 kV) network. The Morwell South sub-transmission network already has 141.36 MW of connected generation. Originally AusNet's sub-transmission network was planned to supply the electricity demand, rather than accommodate renewable generation. The Morwell South sub-transmission network was planned, built, and maintained to meet the demand in that area and is not strong enough to connect significant additional renewable generation.

The Regulatory Investment Test for Distribution (RIT-D) is an economic cost-benefit test used to assess and rank potential investments capable of meeting an identified need. The purpose of the RIT-D is to identify the credible option that addresses the identified need and maximises the present value of net economic benefit to all those who produce, consume and transport electricity in the NEM (the preferred option).

AusNet is initiating this RIT-D to investigate and evaluate options to address the constraints in the MWTS South sub-transmission network which are restricting new renewable generation connections.

Publication of this Options Screening Report (OSR) represents the first step in the RIT-D process in accordance with clause 5.17 of the National Electricity Rules (NER) and section 4.2 of the RIT-D Application Guidelines¹.

AusNet proposes to investigate and evaluate the following network options to address the identified need:

1. Augment MWTS – LGA No.2 line with 19/3.25 AAC conductor;
2. Augment both MWTS - LGA lines with 19/4.75 AAC conductor; and
3. Augment both MWTS - LGA lines with 37/3.75 AAC conductor.

AusNet welcomes written submissions on the credible options presented in this OSR and invites proposals from proponents of potential non-network options (stand-alone or in conjunction with a network solution) that meet the identified need. Any credible non-network options will be assessed alongside the network options at the next stage of the RIT-D.

Submissions should be emailed to ritdconsultations@ausnetservices.com.au on or before 15 April 2024. In the subject field, please reference 'RIT-D OSR CE Morwell South.' AusNet's preference is that these submissions would be published on its website and AEMO's website. If you do not want your submission to be made public, please clearly stipulate this at the time of lodgement.

Assessments of the options and responses to this OSR will be presented in the Draft Project Assessment Report (DPAR), which we expect to publish before the end of May 2024.

¹ Australian Energy Regulator, "Application guidelines Regulatory investment test for distribution", August 2022.

2. Introduction

The RIT-D is an economic cost-benefit test used to assess and rank potential investments capable of meeting the identified need. The purpose of the RIT-D is to identify the credible option that maximises the present value of net economic benefit to all those who produce, consume and transport electricity in the NEM (the preferred option).

The publication of this OSR represents the first step in the RIT-D process in accordance with clause 5.17 of the NER and section 4.2 of the AER's RIT-D Application Guidelines². In accordance with those requirements, this document sets out:

- the identified need that AusNet is seeking to address, together with the assumptions used in identifying this need;
- a description of the credible network options that may address the identified need;
- the technical characteristics of each credible option;
- the classes of market benefits that AusNet considers are unlikely to be material, together with our reasoning;
- the estimated construction timetable and commissioning date; and
- the total indicative capital and maintenance costs for each option.

The appendix provides an overview of the RIT-D assessment and consultation process.

² Australian Energy Regulator, "Application guidelines Regulatory investment test for distribution", August 2022.

3. Background

Morwell Terminal Station (MWTS) 66 kV is the main source of supply for a major part of south-eastern Victoria including Gippsland. AusNet is responsible for planning the transmission connection and distribution network for this region.

MWTS 66 kV is supplied by two 150 MVA 220/66 kV transformers and one 165 MVA 220/66 kV transformer. Maximum demand at MWTS 66 kV typically occurs in summer. The station recorded a maximum demand of 452 MW (464 MVA) in early January 2013. The maximum demand on the station reached 422.3 MW (425 MVA) in winter 2022. The maximum demand period is usually quite short and coincides with a few weeks of peak tourism from Christmas to early January along the east coast of Victoria – however driven by unusually cool 2022/2023 summer conditions the maximum demand occurred in winter 2022. The maximum demand at MWTS 66 kV is forecast to increase over the ten-year planning horizon.

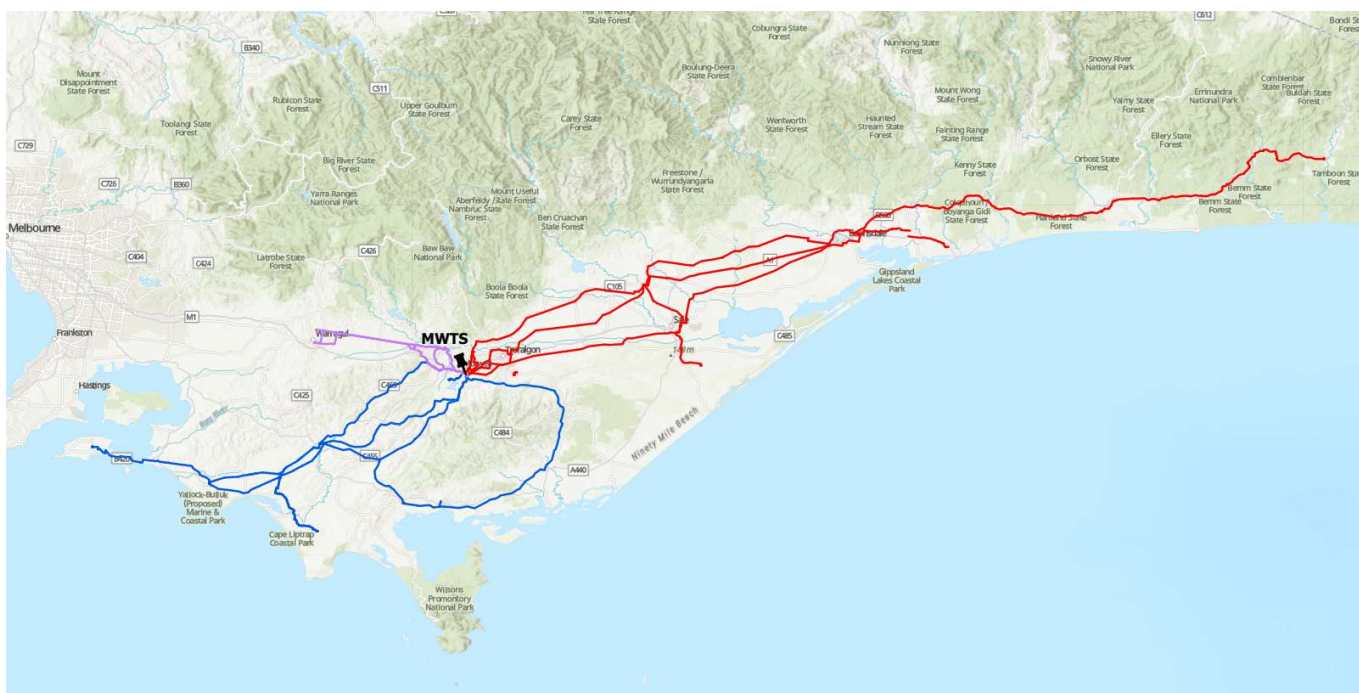

Figure 1: Map showing Morwell Terminal Station and the Morwell sub-transmission network

Morwell South (in blue colour) supplies Phillip Island, Wonthaggi and Leongatha as shown above. Morwell East network (in red colour) supplies Omeo in the north and Bairnsdale and Mallacoota in the east.

A total of 523.7 MW of embedded generation capacity is installed on the AusNet sub-transmission and distribution networks connected to MWTS³. It consists of:

- 277.4 MW of large-scale embedded generation; and
- 246.3 MW of rooftop solar PV, including all the residential and small-scale commercial rooftop PV systems that are smaller than 1 MW.

Of this generation connected to MWTS, Morwell South network has 141.36 MW (more than half) of the large-scale connected generation. In addition, AusNet has received another 865 MW of large-scale generation connection inquiries to connect to the Morwell South network⁴.

³ 2023 Transmission Connection Planning Report (TCPR)

⁴ UpToDate information is available at [Subtransmission Ratings and Connections dashboard](#)

4. Identified need

4.1. Description

As explained in section 3, there is already 141.36 MW of large-scale embedded generation connected to Morwell South network. Recently AusNet has received connection inquiries to connect 865 MW of renewable generation to Morwell South sub-transmission (66 kV) system.

The Morwell Terminal Station (MWTS) to Leongatha (LGA) to Foster (FTR) to Wonthaggi (WGI) to Phillip Island (PHI) 66 kV network supplies over 54,700 customers via the four zone substations at Leongatha, Foster, Wonthaggi and Phillip Island⁵. The following diagram sourced from the Distribution Annual Planning Report (DAPR) – 2024-2028 shows the Morwell South sub-transmission network (note that MWTS-LGA No.2 line is marked in red due to summer load constraint with the line above this being the No.3 line).

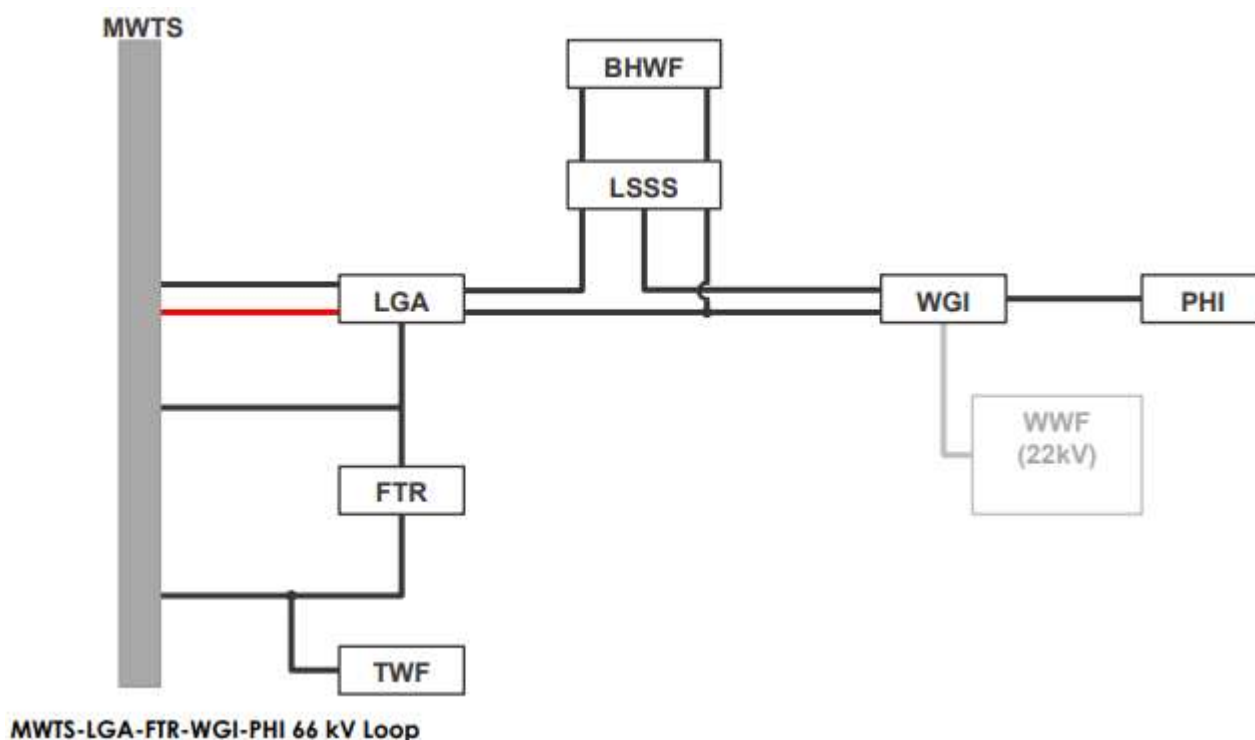

Figure 2: Morwell South sub-transmission network

As shown above a significant portion of the Morwell South (LGA, WGI, PHI substations, Bold Hills wind farm, Wonthaggi Wind farm etc) is connected to MWTS through two 66 kV lines between MWTS and LGA. One of these lines (No.2 line) has a lower summer rating (39.44 MVA) constraining the other line (No.3 line with summer rating 64.59 MVA) operating in parallel. It is evident that this line segment is a major constraint to connecting new generation to the Morwell South network.

Through preliminary studies AusNet has found that only a portion of the proposed generation connections could be connected by the existing assets, and the output of the connected generation would have to be curtailed during peak generation due to the existing constraints of the network.

The identified need of this RIT-D is therefore to address the sub-transmission constraints between MWTS - LGA zone substation (approximately 59 km) to enable more renewable generation to connect to AusNet's sub-transmission and distribution network in Morwell South network.

⁵ AusNet Distribution Annual Planning Report (DAPR) – 2024-2028

4.2.5. Financial risk costs

In the event of an asset failure, costs will be incurred in replacing the failed assets (and any consequential damage to other assets). The risk of this financial impact may vary for different credible options and, therefore, should be factored into the cost-benefit assessment.

5. Potential credible options

This section describes the credible options that have been considered to address the identified need, including:

- the technical characteristics of each option;
- the estimated construction timetable and commissioning date; and
- the total indicative capital and operating and maintenance costs.

The purpose of this RIT-D is to identify the credible option for addressing the identified need that maximises the net market benefit. An important aspect of this task is to consider non-network and network options on an equal footing, so that the optimal solution can be identified.

None of the options considered are expected to have an inter-regional impact. Each credible option is discussed below, including the Do Nothing/BAU option.

5.1. Option 0: Do Nothing/BAU

The Do Nothing/BAU option assumes that AusNet would not undertake any investment, outside of the normal operational and maintenance processes. The Do Nothing/BAU (Business as Usual) option establishes the base level of risk (base case) and provides a basis for comparing other credible options.

5.2. Option 1: Augment No.2 line with 19/3.25 conductor

The existing summer rating of the No.2 MWTS – LGA 66 kV line is 39.44 MVA. During the investigation it was found that a section of the line is already using higher rated AAC (All Aluminium Conductor) conductor, but the rest of the line is using lower rated ACSR (Aluminium Conductor Steel Reinforced) conductor which is constraining the overall line summer rating to 39.44 MVA. This option includes replacing the lower rated line sections with higher rated 19/3.25 AAC conductor to increase the overall line summer rating to match that of the No.3 line, which is operating in parallel. This option is expected to increase the summer rating of both lines from 79 MVA (39.44 x 2) to 128 MVA (64 x 2).

The construction would commence in August 2024, with project completion expected by December 2026. The estimated capital cost of this option is \$25.3 million. In relation to O&M expenditure, AusNet does not expect this option to have a material impact on future O&M costs i.e., routine maintenance expenditure would be substantially unchanged.

5.3. Option 2: Augment both lines with 19/4.75 conductor

This option includes augmenting both MWTS – LGA No.2 and No.3 lines with higher rated 19/4.75 AAC conductor. The summer rating of each line is expected to increase to 105 MVA each, making the overall summer rating between MWTS – LGA close to 210 MVA (105 x 2).

The construction would commence in August 2024, with project completion expected by December 2026. The estimated capital cost of this option is \$56.1 million. In relation to operation and maintenance (O&M) expenditure, AusNet does not expect this option to have a material impact on future O&M costs i.e., routine maintenance expenditure would be substantially unchanged.

5.4. Option 3: Augment both lines with 37/3.75 conductor

This option is similar to option 2 above, the only difference is that this option would replace both lines with a higher rated 37/3.75 AAC conductor. When replacing an existing line with a higher rated conductor, most of the poles will have to be replaced with new poles due to the higher weight of the conductor. Due to other factors like outage requirements, planning permits etc it may be economical to augment with a higher rated conductor. This augmentation will increase the summer rating of each line to 118 MVA, making the new overall MWTS – LGA summer rating 236 MVA (118 x 2).

The construction would commence in August 2024, with project completion expected by December 2026. The estimated capital cost of this option is \$58.3 million. In relation to O&M expenditure, AusNet does not expect this option to have a material impact on future O&M costs i.e., routine maintenance expenditure would be substantially unchanged.

5.5. Options considered and not progressed

The option of augmenting the No.2 line with 19/4.75 AAC or 37/3.75 AAC was considered but did not progress further. In the absence of augmenting the No.3 line, this option would not provide any additional benefits as No.2 and No.3 lines are operating in parallel. Under this option, the No.3 line rating would be the constraining factor and the overall summer rating between MWTS – LGA would be limited to 128 MVA (64 x 2).

5.6. Material inter-regional network impact

The proposed augmentations between MWTS - LGA will not change the transmission network configuration and none of the network options considered are likely to have a material inter-regional network impact. A 'material inter-regional network impact' is defined in the NER as:

"A material impact on another Transmission Network Service Provider's network, which may include (without limitation): (a) the imposition of power transfer constraints within another Transmission Network Service Provider's network; or (b) an adverse impact on the quality of supply in another Transmission Network Service Provider's network."

6. Non-network options

This section outlines:

- The technical characteristics that a non-network option would be required to deliver;
- The estimated maximum deferred augmentation charge that would be available to pay for the non-network service; and
- The information that a non-network proponent should provide to AusNet to explore the potential provision of a non-network service.

6.1. Required technical characteristics of a non-network option

The table below sets out the curtailment reductions that a non-network option placed preferably at Leongatha connecting to Leongatha Zone Substation would be required to deliver. The non-network option would mitigate the risks associated with the curtailed renewable generation from existing generators in the South Gippsland loop and from new generation connecting to Leongatha zone substation due to the constraints between MWTS – LGA sub-transmission section. The information presented provides an indication of the required operating profile, noting that prospective non-network service providers may not be able to exactly match these requirements.

Table 1: Service requirements for a non-network option

Year (FY)	Total Curtailment Relief (GWh)	Total Hours of Curtailment Relief	Maximum Duration of Curtailment Relief (hours)	Total Amount of Curtailment Relief During Maximum Duration Event (MWh)	Average Daily Hours of Curtailment Relief	Average Daily Curtailment Relief (MWh)
2027	97.63	2138	24	1708.5	5.86	267.47
2028	103.67	2238	24	1890.22	6.13	284.01
2029	118.99	2163	24	2041.95	5.93	326.00
2030	94.59	2113	24	1821.15	5.79	259.14
2031	88.66	2011	24	1820.06	5.51	242.90
2032	88.76	2021	24	1862.42	5.52	242.50
2033	73.16	1994	24	1507.65	5.46	200.45
2034	73.42	1984	24	1544.72	5.44	201.16

6.2. Power system security, reliability and fault levels

A non-network option must be capable of reliably reducing curtailed generation under a range of conditions and scenarios. The non-network solution will contribute to system security and reliability to the extent that it addresses the risks arising from the identified need. The non-network option is not required to address any existing issues in relation to fault levels.

If the non-network option is an inverter-based generator operating in parallel with AusNet's network, the generator must comply with the requirements set out in document SOP 33-05 and other connection requirements which are set out in AusNet Services' [embedded generator connections page](#).

6.3. Guidance on potentially feasible options

The following non-network solutions are likely to be potentially feasible options to address the identified need:

- New embedded energy storage systems or load connections;
- Modifications to existing customer generation to include embedded energy storage systems; and
- Modifications to existing load connections to increase load capacity.

Without limiting the potential for non-network solutions, the following types of non-network options are unlikely to be feasible:

- Renewable generation not coupled with storage or dispatchable generation; and
- Unproven, experimental or undemonstrated technologies.

6.4. Information to be included in non-network solution proposals

Non-network service providers interested in alleviating the network constraints outlined above are advised to begin engagement with AusNet as soon as possible. A detailed proposal including the information listed below should be submitted by the requested date.

Details required include:

- Name, address and contact details of the person making the submission.
- Name, address and contact details of the person responsible for non-network support (if different to above).
- A detailed description of the services to be provided, including:
 - Size and capacity (MW/MVA/MWh).
 - Location(s).
 - Frequency and duration.
 - Type of action or technology proposed, including response / ramp rate information, where applicable.
 - Proposed dispatching arrangement (e.g. telephone, web-based trigger, automated means via RTU).
 - Availability and reliability performance details.
 - Period of notice required to enable dispatch of non-network support (e.g. to allow time for charging of energy storage solutions or market-based limitations).
 - Proposed contract period and staging (if applicable).
 - Proposed timing for delivery (including timeline to plan and implement the proposal).
- High-level electrical layout of the proposed site (if applicable).
- Evidence and track record proving capability and previous experience in implementing and completing projects of the same type as the proposal.
- Preliminary assessment of the proposal's impact on the network.
- Breakdown of the lifecycle costs for providing the service, including:

- Capital costs (if applicable).
- Annual operating (i.e. set up and dispatch fees) and maintenance costs.
- Other costs (e.g. availability, project establishment, etc.).
- Tariff assumptions.
- Expected annual payment for providing the non-network solution
- A method outlining measurement and quantification of the agreed service, including integration of the proposed solution with the network.
- A statement outlining that the non-network service provider is prepared to enter into a Network Support Agreement (NSA) (subject to agreeing terms and conditions).
- Letters of support from partner organisations.
- Any special conditions to be included in an NSA.

All proposals must satisfy the requirements of any applicable laws, rules, and the requirements of any relevant regulatory authority, including following the normal network connection processes where applicable. Any network reinforcement costs required to accommodate the non-network solution will typically be borne by the proponent of the non-network solution.

For further details on AusNet's process for engaging and consulting with non-network service providers, and for investigating, developing, assessing and reporting on non-network options as alternatives to network augmentation, please refer to the Non-Network Solutions and Demand Management webpages, which contain the Demand Side Engagement Strategy and other relevant demand management documentation:

<https://www.ausnetservices.com.au/Electricity>

6.5. Potential payments to non-network proponents

The maximum amount that AusNet would be willing to pay for a non-network solution would depend on the value that it provides in terms of risk reduction.

At this stage, the preferred network option has not yet been determined. As a consequence, the total capital expenditure that could be deferred by engaging a non-network solution and, therefore, an estimate of the annual payment available to a non-network proponent cannot be provided.

The payment for a non-network solution may vary according to availability, capacity, dispatch duration and firmness of the non-network service, and the responses received from other non-network proponents. The actual payment to a non-network proponent will also be subject to negotiation.

AusNet welcomes the submission of non-network option proposals for review of the potential payment amount on a case-by-case basis. For more information or enquiries regarding non-network solutions to address the identified need, please ritdconsultations@ausnetservices.com.au. In the subject field, please reference 'RIT-D OSR CE Morwell South.

7. Next steps

7.1. Request for submissions

AusNet invites written submissions, on the matters set out in this OSR, from Registered Participants, AEMO, interested parties, non-network providers and those registered on our demand-side engagement register.

All submissions and enquiries should be directed to:

Email: ritdconsultations@ausnetservices.com.au

Submissions are due on or before 15 April 2024 and should refer to 'RIT-D OSR CE Morwell South in the subject heading.

Submissions will be published on AusNet's and AEMO's websites. If you do not wish to have your submission published, please clearly stipulate this at the time of lodging your submission.

7.2. Next stage of RIT-D process

Following the conclusion of the consultation period for this report, AusNet will, having regard to any submissions received, prepare and publish the DPAR which will include:

- A summary of, and commentary on, any submissions on this OSR;
- A detailed market benefit assessment of the proposed credible options to address the identified need; and
- Identification of the proposed preferred option to meet the identified need.

AusNet expects to publish before the end of May 2024.

Appendix – RIT-D assessment and consultation process¹³

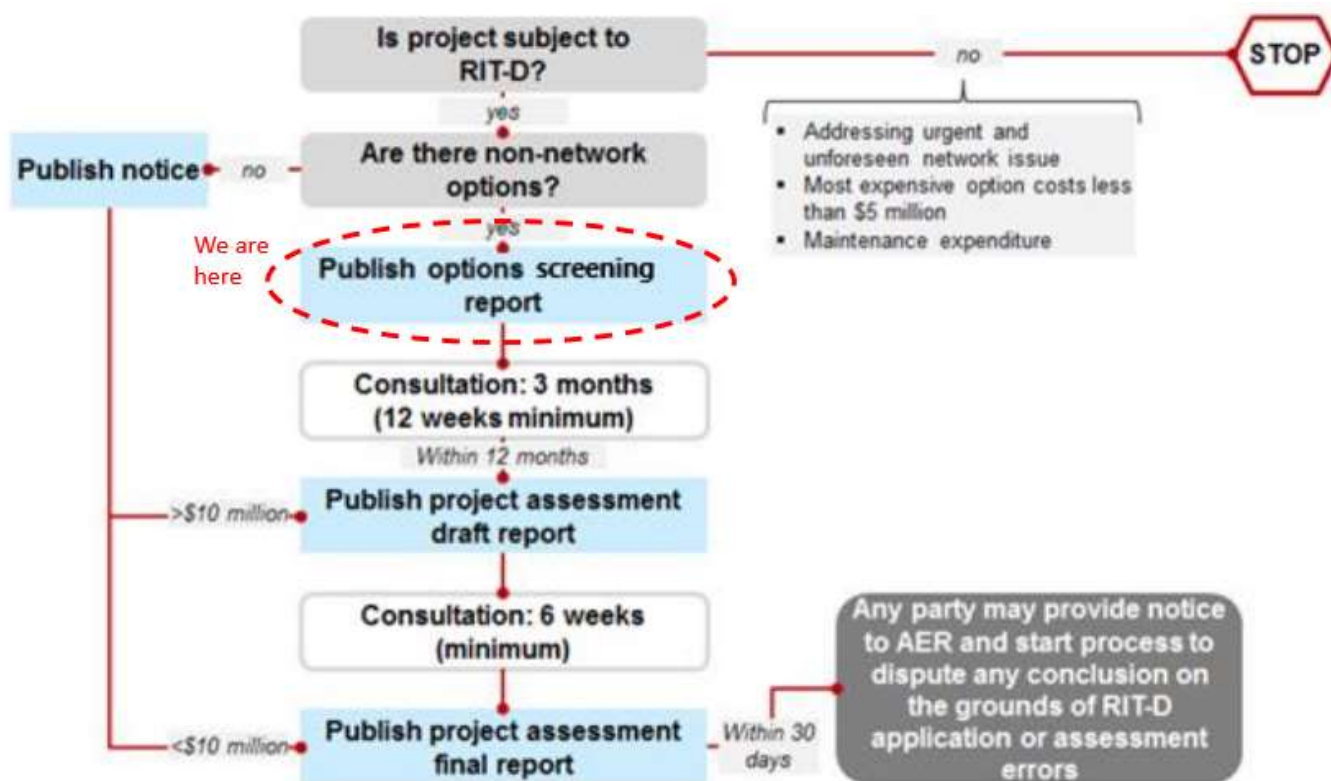



¹³ Section 4 - Australian Energy Regulator, "Application guidelines Regulatory investment test for distribution" August 2022

AusNet Services

Level 31
2 Southbank Boulevard
Southbank VIC 3006
T +613 9695 6000
F +613 9695 6666
Locked Bag 14051 Melbourne City Mail Centre Melbourne VIC 8001
www.AusNetServices.com.au

Follow us on

-  @AusNetServices
-  @AusNetServices
-  @AusNet.Services.Energy

AusNet

